

TOP VIEW

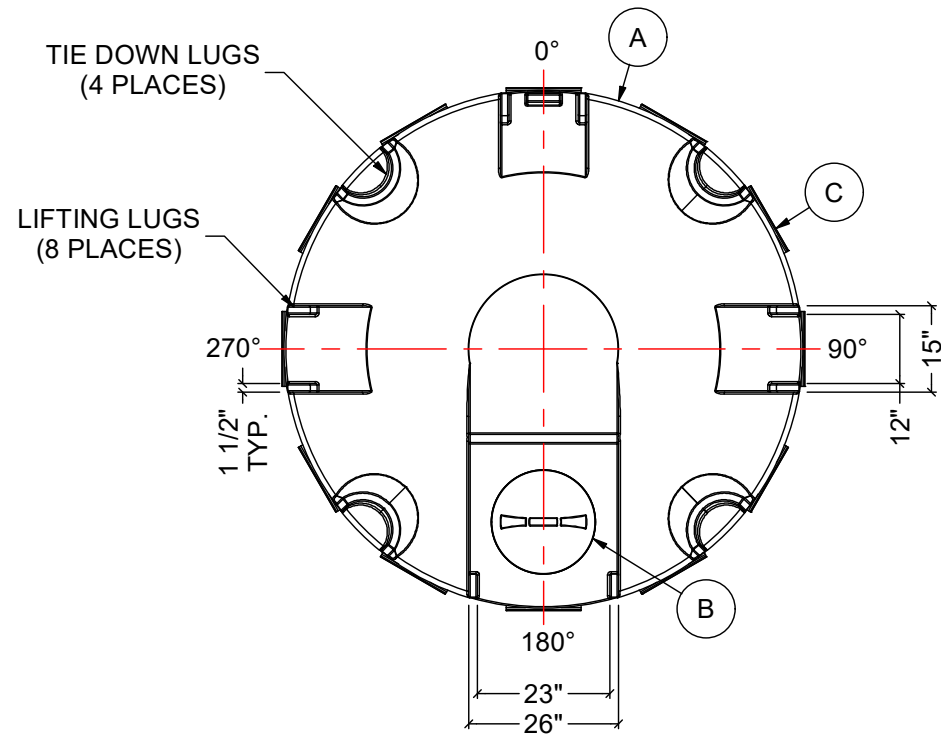

NOTES:

1. TANK IS MANUFACTURED FROM POLYETHYLENE (PE) OR CROSSLINK PE (XLPE).
2. RATING FOR STORING LIQUIDS WITH A SPECIFIC GRAVITY (DENSITY) OF 1.5SG. (1.9SG ALSO AVAILABLE)
3. ALL TANK DIMENSIONS ARE SUBJECT TO A +/-3% TOLERANCE.
4. ALL EXTERNAL PIPING AND ACCESSORIES MUST BE FULLY SUPPORTED AND FLEXIBLE TO AVOID STRESSING THE TANK.
5. FITTING GASKETS AVAILABLE IN EPDM OR VITON.
6. TANK MUST BE PROPERLY VENTED TO PREVENT PRESSURE OR VACUUM FROM DEVELOPING AS THE TANK IS FILLING OR EMPTYING.

MATERIALS LIST

ITEMS	DESCRIPTION	NOTES
A	CBC-2490 CONE BOTTOM TANK	
B	15" THREADED LID	
C	STEEL STAND FOR CBC-2490	

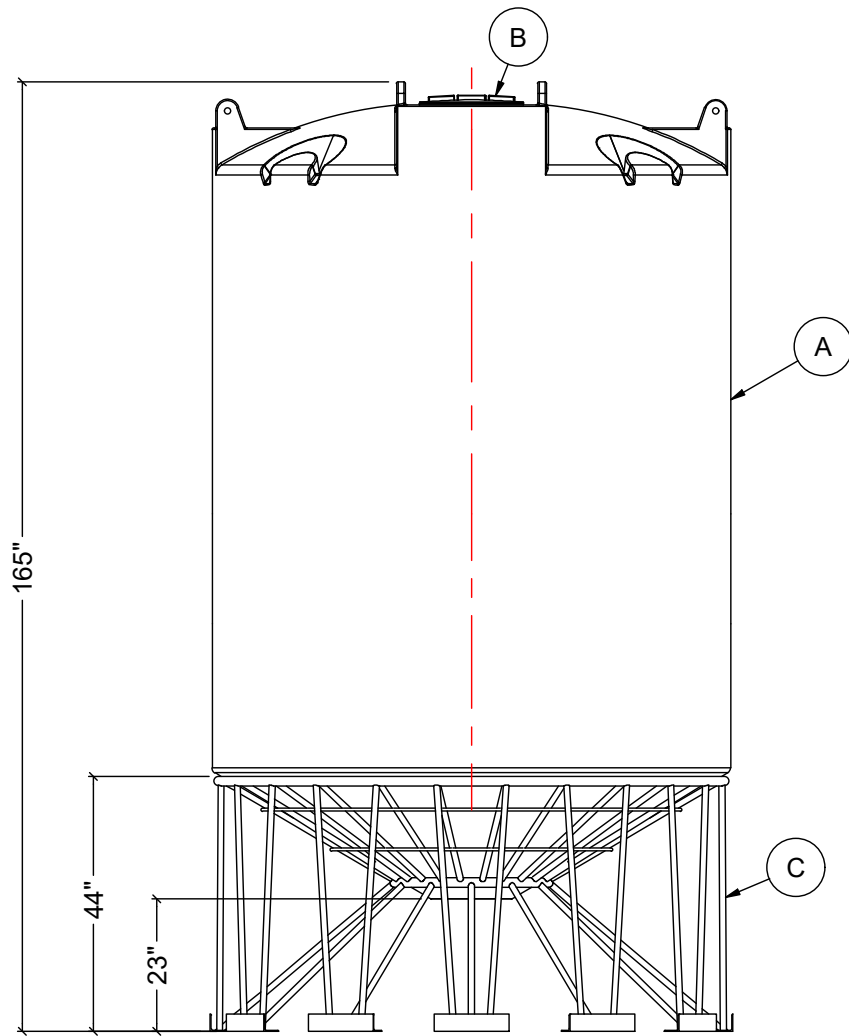
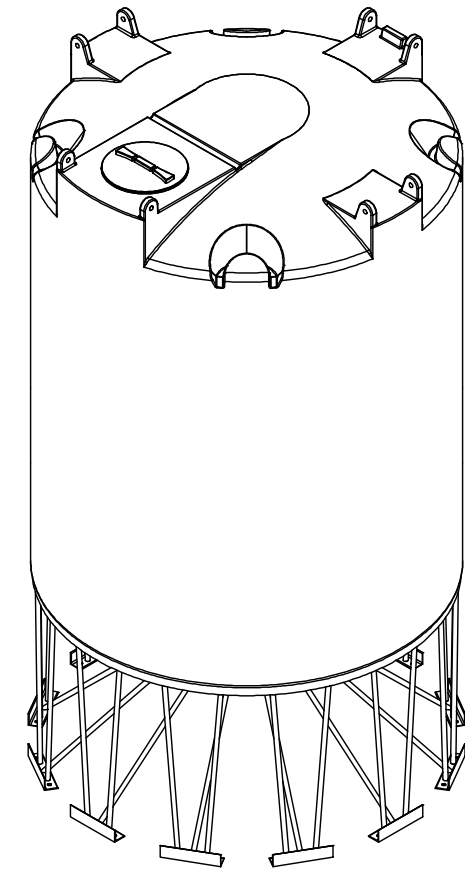

FRONT VIEW

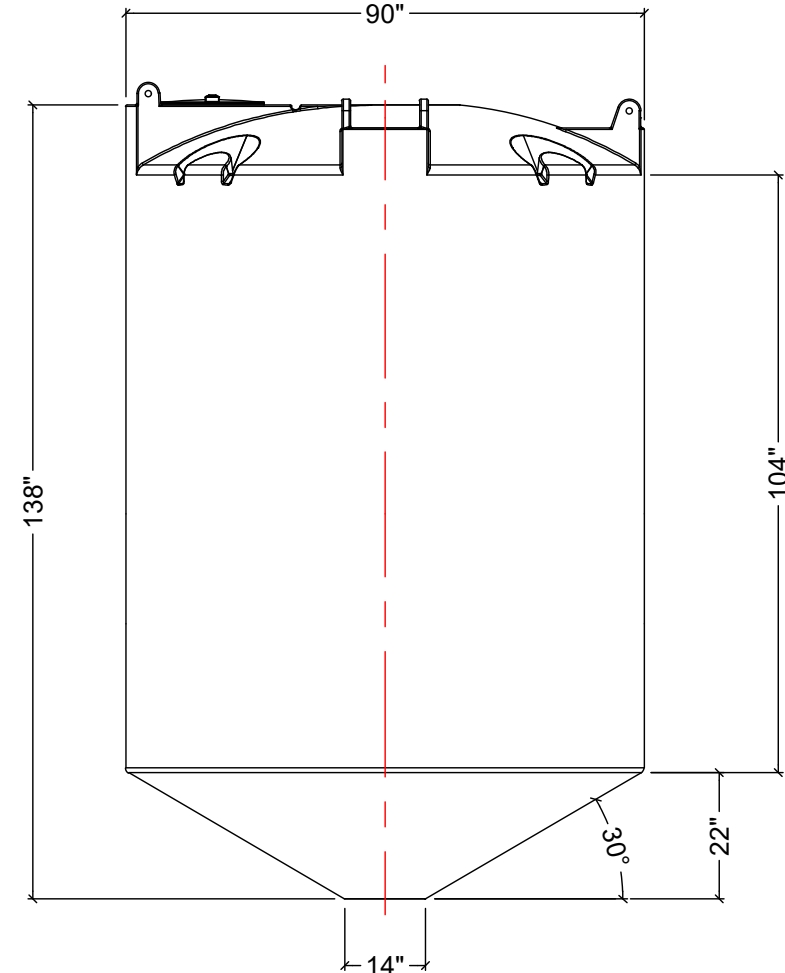

SIDE VIEW

REV	DATE	DESCRIPTION	BY	APPD	REVD
REVISIONS					
CUSTOMER					
TITLE		ACO JOB NO:			
2500 IG CONE BOTTOM TANK		PURCHASE ORDER NO:			
		PURCHASER'S EQUIP. NO:			
THIS DRAWING IS THE PROPERTY OF ROTOPLAST INC. AND SHALL NOT BE COPIED OR TRANSFERRED WITHOUT THE WRITTEN CONSENT OF ROTOPLAST INC.					
ENGINEERS SEAL		ACO CONTAINER SYSTEMS DIVISION OF ROTOPLAST INC.			
<small>PICKERING - ONTARIO - CANADA</small>					
<small>ACO CONTAINER SYSTEMS</small>		<small>DESIGNED</small>			
<small>DIVISION OF ROTOPLAST INC.</small>		<small>DRAWN</small>	<small>WM</small>		
<small>794 MCKAY RD.</small>		<small>CHECKED</small>			
<small>PICKERING, ONTARIO, CANADA</small>		<small>APPROVED</small>			
<small>TEL. 905-683-8222</small>		<small>SCALE</small>	<small>N.T.S.</small>		
<small>FAX 905-683-2969</small>		<small>DATE</small>	<small>29-03-16</small>		
<small>DWG No</small>		CBC-2490		<small>REV</small>	0